

# MK Alat dan Mesin Pengolahan

## Kuliah ke-6

### Alat/Mesin Pengekstrak dan Pembentuk

Prof.Dr.oec.troph.Ir.Krishna Purnawan Candra, M.S.

Jurusan Teknologi Hasil Pertanian

Faperta Unmul

## Alat Pengekstrak

- Alat pengekstrak adalah alat yang digunakan untuk mengekstrak satu jenis bahan tertentu dari bahan baku
- Jenis alat pengekstrak
  - Mekanik
    - Tekan (kempa) dengan dongkrak atau dorongan
    - Ulir/*Screw (Expeller)*
  - Sentrifugal
    - Sentrifus
  - Ekstraksi kimia (*Solvent extraction*)

# Alat Pengekstrak Mekanik

- Tekan/kempa

- Ulir / screw / expeller

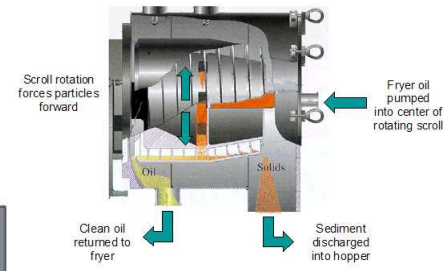
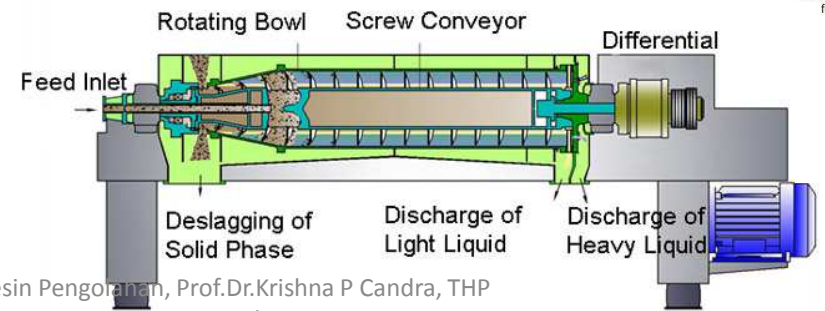
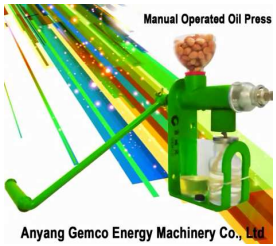

Alat dan Mesin Pengolahan, Prof.Dr.Krishna P Candra, THP Faperta Unmul

# Alat Pengekstrak Sentrifugal dan pengekstrak solven

- Alat pengesktrak sentrifugal

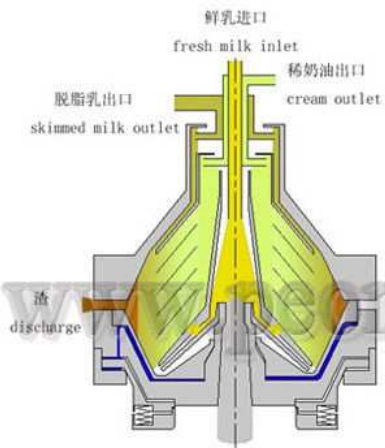
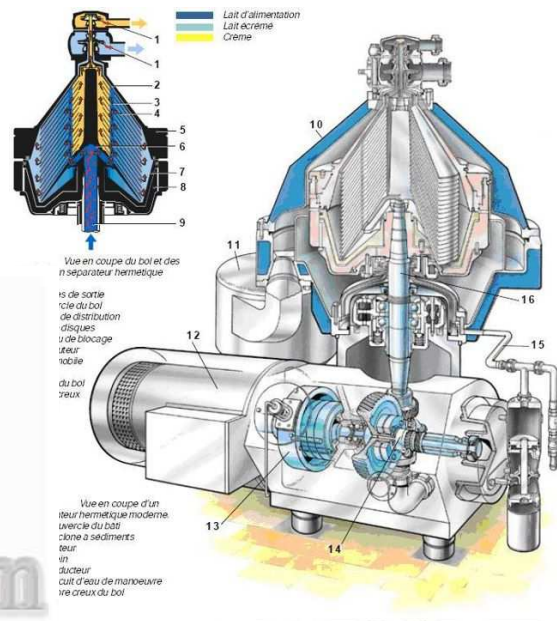

Alat dan Mesin Pengolahan, Prof.Dr.Krishna P Candra, THP Faperta Unmul

- Alat pengekstrak solven

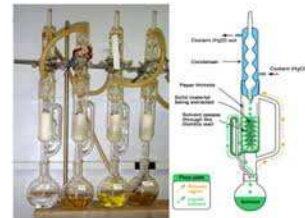
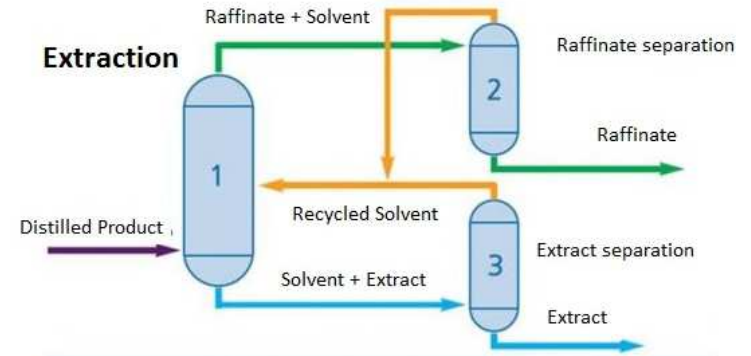

# Alat Penghalus/pembentuk (Ekstruder)

